



**YOUR PARTNER IN  
ELECTRICAL CONTROL PANEL ACCESSORIES**



E-CATALOGUE

# REJECT SINGLE USE PLASTIC

## GREEN INDUSTRIAL REVOLUTION

PeCox uses only  
Engineering Grade Recyclable  
Thermoplastic We do not use any  
form of Single Use Plastic  
Thermoset plastic category such as  
DMC, SMC, Bakelite, Mellamine, etc...

63

Countries have extended producer responsibility or companies to take back single-use plastic from consumers

27

Countries have banned specific products like plates, cups and straws or material like polystyrene

8

Countries have banned Microbeads, which are plastic particles less than or equal to 5mm size

"The choices that we make today will define our collective future"  
...India has pledged to eliminate all single use plastic by 2020 and ...so do We...

 Save EARTH...Think **PeCOX**  
Quality Never Dies  
[www.pecox.co.in](http://www.pecox.co.in)





## Who Are We

PeCox is an upcoming name in the field of “Electrical Control Panel Accessories”. Established in the year 2015, with an ultimate aim of serving the Control Panel Industry with an extremely Innovative Concept, Strategic Design saving Labor-cost bundled with Extraordinary Quality.

PeCox has been started by a team of professionals who have rich expertise of plastic vertical, mechanical vertical & the practical experience in the Electrical Control panel industry. Product range is categorized into 4 verticals- Panel Hardware, Cable Termination, Cable Management & Marking and Polyamide Low Voltage bus bar supports.



## Company Vision

At PeCox, our objective is to create a range of world class Electrical Control Panel Accessories uniquely designed & crafted to achieve a sustainable growth with a key focus on the Environment. Our commitment to the Control Panel Industry... “Distinctive & Compact Designs(which also saves Labor cost) Recyclable/Eco Friendly Raw materials, Better Insulation at Affordable Pricing”.

## Company Mission

At PeCox, we understand the technical hitches in the traditionally enduring panel accessories and so have developed a range of products which help overcome these typical problems. Our endeavour is to develop world class Eco-Friendly panel accessories by substituting their basic raw material from THERMOSET to GLASS-FILLED ENGINEERING GRADE THERMOPLASTIC which exhibits:

- Recyclable in nature
- Superior degree of Mechanical & Electrical Strength
- High Tensile Strength

Unique & aesthetically astounding designs have been crafted keeping the mounting alike. Most of the products comply with RoHS directives & meet the requisite parameter of Ingression Protection (IP), High Voltage, Flame Retardant, Load Bearing Test, Torque Test etc as and where required duly tested by third party laboratories such as CPRI, Spectro, SGS etc. Taking into consideration all the aspects we have still tried to bridge the gap of price & quality by adopting the multi-cavity production technique.



# CONTENT

## PANEL AIR VENT - SCREW TYPE

<b>MATERIAL</b>	ENGINEERING GRADE THERMOPLASTIC
<b>COLOR</b>	PECOX - RAL7035/BLUE/ORANGE P-KONNECT - GREY

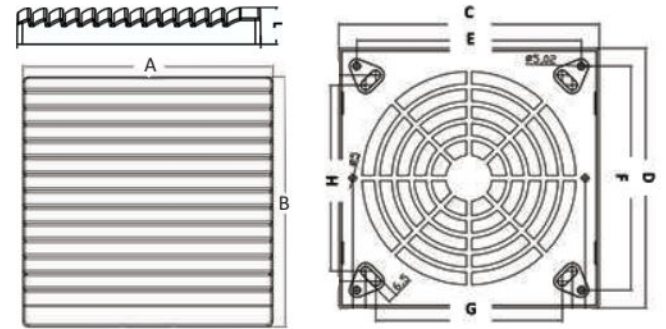

### WHY PECOX?

- > "Twist -to-Open" for outer cover.
- > "Curve Shaped" exaggerates the heat dissipation & protect from the direct impact of dust.
- > "Additional fan mounting" for next lower fan size

### TECHNICAL DATASHEET

PRODUCT CODE	FRONT		SIZE(mm) BACK		PANEL MOUNTING		FAN MOUNTING SIZE(mm)		FILTER HEIGHT	FOR FAN SIZE (inch)
	A	B	C	D	E	F	G	H		
PAV/PKF01	131	131	127	127	105	105	90±3	90±3	25	4"
PAV/PKF02	185	185	180	180	155	155	134±5	134±5	27	6"
PAV/PKF03	238	238	231	231	203	202	170±3	170±3	31	8"

### ECO - SERIES - P Konnect

PRODUCT CODE	LIST PRICE (INR)	UNIT	STANDARD PKG	MASTER PKG	PRODUCT CODE	LIST PRICE (INR)	UNIT	STANDARD PKG	MASTER PKG
PKF01	51.00	No.	1	300	PAV01	71.50	No.	1	300
PKF01 VP*	47.25	No.	10	300	PAV01 VP*	68.00	No.	10	300
PKF02	109.00	No.	1	150	PAV02	170.00	No.	1	150
PKF03	213.00	No.	1	80	PAV03	327.00	No.	1	80

### PREMIUM - SERIES - PECOX

\*VP - Value Pack PKT = 10 Nos

## FAN ATTACHMENT UNIT

<b>MATERIAL</b>	ENGINEERING GRADE THERMOPLASTIC
<b>COLOR</b>	RAL7035 - Grey

### WHY PECOX?

- > Fan Attachment Unit act as a Mounting unit for Fans wherein the air vents are not used.
- > Compatible with Air Vents PAV06/PAV02/PKF02/PAV02S making it a Fan Mounting Unit (Dome Type) panel air vent

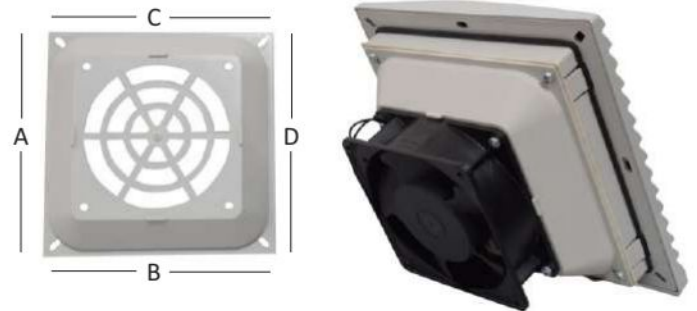

### TECHNICAL DATASHEET / PACKAGING / PRICING

PRODUCT CODE	LIST PRICE (INR)	UNIT	SPECIFICATION	DIMENSIONS				STANDARD PKG	MASTER PKG
				A	B	C	D		
PAV06FA	98.00	No.	Suitable for Mounting 4" Fan	175	175	175	175	5	90

## PANEL AIR VENT - SLEEK DESIGN

MATERIAL	ABS
GASKET	EPDM SPONGE RUBBER
COLOR	RAL7035/BLUE/ORANGE

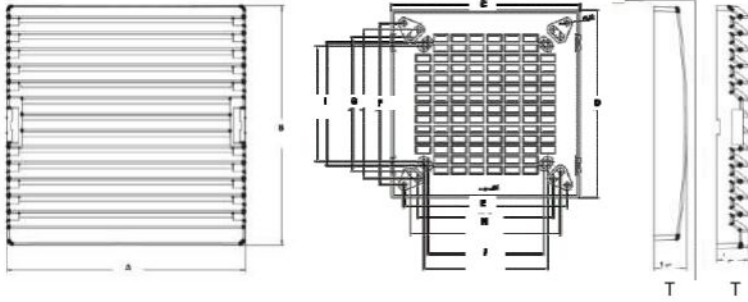

### 💡 WHY PECO?™

- > "Curve Shaped" accelerates heat dissipation & protects from direct impact of dust.
- > Optional Internal Locking system of cover.
- > Optional for next Lower Size Fan mounting option.
- > Ip54 Protection / RoHS – Tested by Spectro Lab / SGS.

### TECHNICAL DATASHEET

PRODUCT CODE	FRONT		SIZE(mm) BACK			PANEL MOUNTING		FAN MOUNTING PROVISION(mm)		FOR FAN SIZE(inch)	ADD FAN MOUNTING PROVISION (mm)		ADD FAN SIZE(Inch)
	A	B	C	D	T	E	F	G	H	I	J		
PAV00S	92	92	87	87	14	71	71	71	71	3"	NA	NA	NA
PAV01S	131	131	127	127	17	90	90	105	105	4"	NA	NA	3"
PAV02S	185	185	180	180	19	134	134	155	155	6"	110	110	4"

### PACKAGING & PRICING

PRODUCT CODE	LIST PRICE (INR)	UNIT	STANDARD PKG	MASTER PKG	PRODUCT CODE	LIST PRICE (INR)	UNIT	STANDARD PKG	MASTER PKG
PAV00S	58.00	No.	1	600	PAV01S VP*	67.00	No.	10	300
PAV01S	70.00	No.	1	300	PAV02S	158.00	No.	1	150

\*VP - Value Pack PKT = 10 Nos



## PANEL AIR VENT CUM BREATHER

MATERIAL	POLYCARBONATE UV STABILIZED
GASKET	EPDM
COLOR	RAL7035 - GREY
IP RATING	Ip65

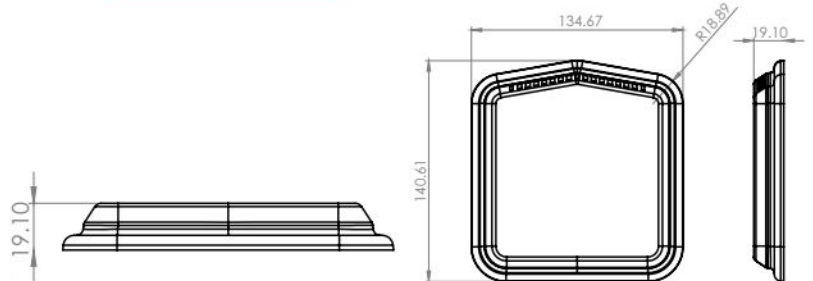

### 💡 WHY PECO?™

- > Ip65 Protection - Best suitable for outdoor application.

### PACKAGING & PRICING

PRODUCT CODE	LIST PRICE (INR)	UNIT	DESCRIPTION	STANDARD PKG	MASTER PKG
PAV10UV	400.00	No.	Ip65 AIR VENT CUM BREATHER	10	20



## PANEL AIR VENT - SNAP/PUSHFIT

<b>MATERIAL</b>	ABS
<b>COLOR</b>	RAL7035/BLUE/ORANGE EPDM SPONGE RUBBER

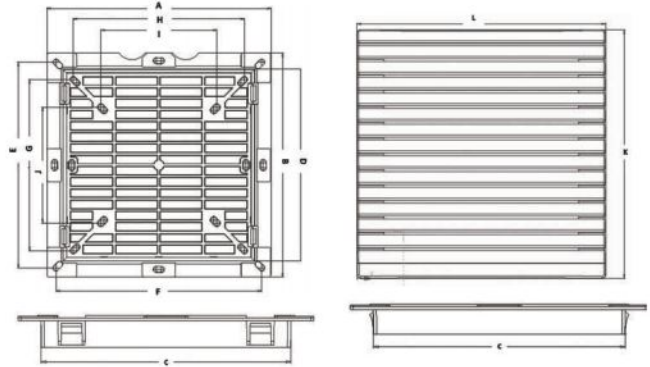

### WHY PECOx?

- > "Curve Shaped" accelerates heat dissipation & protects from direct impact of dust.
- > Optional Internal Locking system of cover.
- > Optional for next Lower Size Fan mounting option.
- > Ip54 Protection/RoHS –Tested by Spectro Lab/ SGS

### TECHNICAL DATASHEET

PRODUCT CODE	OVERALL SIZE(mm)		CUT OUT SIZE(mm)		SCREW MOUNTING PROVISION(mm)		FAN MOUNTING PROVISION(MM)		FOR FAN SIZ(inch)	ADD FAN MOUNTING PROVISION(mm)		FOR FAN ADD SIZE(Inch)
	A	B	C	D	E	F	G	H	I	J		
PAV04/PKF04	145	145	122.5	122.5	137	137	107.8	107.8	4"	NA	NA	NA
PAV06/PKF06	208	208	176.5	176.5	191	191	159.3	159.3	6"	107.8	107.8	4"
PAV07	254	254	222.5	222.5	239	239	202.9	202.9	8"	159.3	159.3	6"
PAV08	316	316	290.5	290.5	304	304	262.0	262.0	10"	202.9	202.9	8"

### PREMIUM-SERIES-PECOX

### ECO - SERIES - P Konnect

Product Code	List Price (INR)	Unit	Standard PKG	Master PKG	Product Code	List Price (INR)	Unit	Standard PKG	Master PKG
PAV04	103.00	No.	1	240	PKF04	80.00	No.	10	240
PAV04 VP*	95.00	No.	10	240	PKF06	175.00	No.	5	90
PAV06	245.00	No.	1	90					
PAV07	372.00	No.	1	55					
PAV08	780.00	No.	1	30					

## DRAWING POCKET

<b>MATERIAL</b>	ENGINEERING GRADE THERMOPLASTIC
<b>COLOR</b>	RAL7035 - Grey

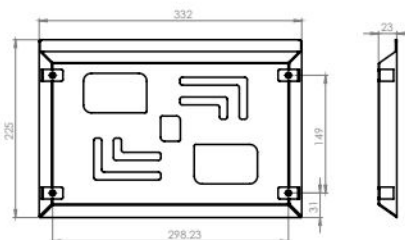

### WHY PECOx?

- > Unique Design with provision of horizontal placement of A4 papers

### TECHNICAL DATASHEET / PACKAGING / PRICING

PRODUCT CODE	LIST PRICE (INR)	UNIT	MOUNTING DIMENSIONS	STANDARD PKG	MASTER PKG
PDP01	130.00	No.	298.23 x 149 mm	5	200

## METER WINDOW GLASS - SCREW FIT

MATERIAL	CRYSTAL
GASKET	SPONGE RUBBER
COLOR	TRANSPARENT CLEAR



PKMG01

### WHY PECOx?

- > Pre-fitted "Sponge Rubber Gasket" in the meter glass, saves fitment time.

### TECHNICAL DATASHEET / PACKAGING / PRICING

PRODUCT CODE	LIST PRICE (INR)	UNIT	SPECIFICATION	STANDARD PKG	MASTER PKG
PKMG01	35.00	No.	96 x 96 mm	20	600

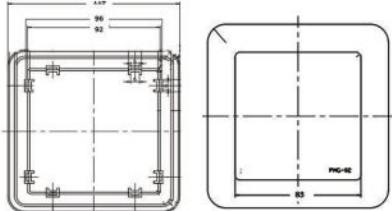

PMG02

- > Saves Labor time - No drilling & fixing screws.
- > Polycarbonate reduces the probability of Breakage during the transit.

## METER WINDOW GLASS - SNAP FIT

MATERIAL	CRYSTAL
GASKET	SPONGE RUBBER
COLOR	TRANSPARENT CLEAR



PMG03

### WHY PECOx?

- > UV Stabilized Polycarbonate material makes it more transparent & insurgents to any weather conditions.
- > RoHS- Certified

### TECHNICAL DATASHEET / PACKAGING / PRICING

PRODUCT CODE	LIST PRICE (INR)	UNIT	OVERALL SIZE (mm)	CUT OUT SIZE (mm)	STANDARD PKG	MASTER PKG
PMG02	62.50	No.	96 x 96	92 x 92	20	600
PMG03	140.00	No.	118.5 x 211	92 x 184	5	300

## LATCH TYPE/DB LOCK

MATERIAL	ENGINEERING GRADE THERMOPLASTIC
COLOR	PDB01 - LIGHT GREY (RAL 7035) PDB01DG - DARK GREY PDB01N - BLACK

### WHY PECOx?

- > Preminent spring quality.
- > Side pillars on both the sides helps in self adjustment if any minor deviation in the cutout size.

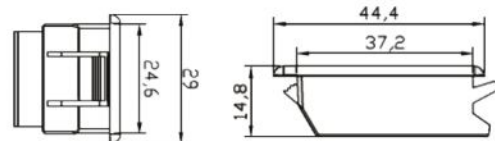

### PACKAGING & PRICING

PRODUCT CODE	LIST PRICE (INR)	UNIT	CUTOUT SIZE (mm)	STANDARD PKG	MASTER PKG
PDB01/ PDB01DG / PDB01N (Grey) (Dark Grey) (Black)	13.00	No	37.2 x 24.6	100	3000





## PANEL LOCK - METTALIC

SIZE	22.5 mm
BODY	ZINC ALLOY (ZAMARK3)
INSERT	ZINC ALLOY (ZAMARK3)
LEVER	MS LEVER (CHROME PLATED)
CHUCKNUT	ZINC ALLOY(CHROME PLATED)
GASKET	EPDM

### WHY PECOx?

- > Chucknut with Kurling for proper griping.
- > EPDM Gasket to provide IP54 protection.

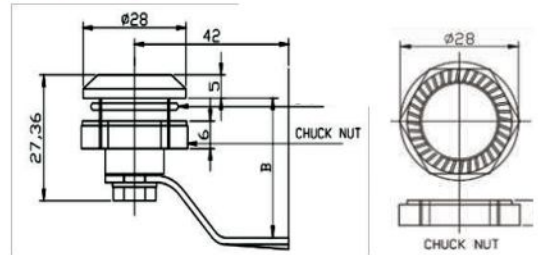
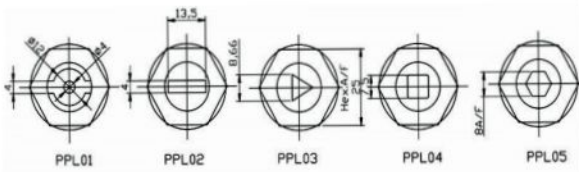

### PACKAGING & PRICING

PRODUCT CODE	LIST PRICE (INR)	UNIT	LEVER BEND (mm)	STANDARD PKG	MASTER PKG
PPL01/02/03/04/05 - 20/25	80.00	No.	20/25	25	600
PPL01/02/03/04/05 - 30/45	88.00	No.	30/45	25	600

## PANEL KEY

MATERIAL	ZINC ALLOY (ZAMARK3)
INSERTS	CENTER PIN, MINUS, SQUARE TRIANGLE, HEXAGONAL



### WHY PECOx?

- > Compact Design to accommodate easily in key-chain.

### PACKAGING & PRICING

PRODUCT CODE	LIST PRICE (INR)	UNIT	SPECIFICATION	STANDARD PKG	MASTER PKG
PPLK01/02/03/04/05	39.00	No.	22.5 mm	25	600



## PANEL LOCK - KNOB TYPE

SIZE	22.5 mm
BODY	POLYAMIDE
KNOB	ALUMINUM DICASTING/ POLYAMIDE
LEVER	MS LEVER (CHROME PLATED)
CHUCKNUT	ZINC ALLOY(CHROME)/ POLYAMIDE
GASKET	EPDM
CUT-OUT	19.4 x 19.4 mm

### WHY PECOx?

- > Knob Type lock is duly powder coated & in combination with polyamide body, reduces risk of corrosion.

### PACKAGING & PRICING

PRODUCT CODE	LIST PRICE (INR)	UNIT	KNOB MATERIAL	CHUCKNUT TYPE	STANDARD PKG	MASTER PKG
PPLP-T1M	60.00	No.	Aluminum casting	ZINC	20	360
PPLP-T2P	57.50	No.	Polyamide	POLYAMIDE	20	360

## PANEL LOCK - POLYAMIDE

SIZE	22.5 mm
BODY	POLYAMIDE
INSERT	ALUMINUM/ZINC PRESS DICASTING
LEVER	MS LEVER (CHROME PLATED)
CHUCKNUT	ZINC ALLOY(CHROME)/ POLYAMIDE
GASKET	EPDM
PANEL CUT-OUT	19.4 x 19.4 mm



PPLPZ-M/P SERIES

PPLP-M/P SERIES

### CENTER PIN/ MINUS/ TRIANGLE/ SQUARE/ HEXAGONAL

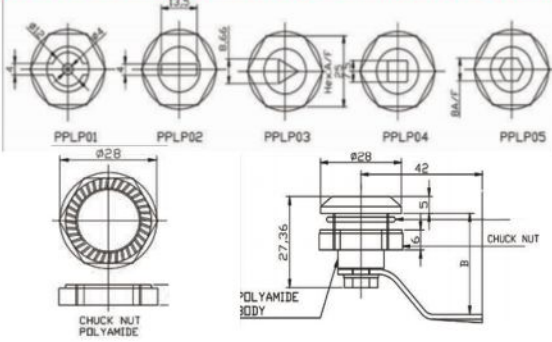

### 💡 WHY PECOx?

- > Polyamide chucknut is spanner operated which ease the fastening process.
  - > EPDM Gasket provides IP54 protection to the panels.
  - > Zinc/Polyamide Heavy Chucknut with knurling provides proper gripping.
  - > Powder Coated(RAL7035) Inserts contrast with the Panel Color, making it aesthetically better.
- Ip54 - TESTED.

### TECHNICAL DATASHEET / PACKAGING / PRICING

PRODUCT CODE	LIST PRICE (INR)	UNIT	INSERT MATERIAL	CHUCKNUT TYPE	STANDARD PKG	MASTER PKG
PPLPZ - 01/02/03/04/05M	48.50	No.	Zinc	Zinc	25	600
PPLPZ - 01/02/03/04/05P	46.00	No.	Zinc	Polyamide	25	600
PPLP - 01/02/05M	41.25	No.	Aluminum	Zinc	25	600
PPLP - 01/02/05P	38.75	No.	Aluminum	Polyamide	25	600

## PANEL LOCK - RUST FREE



PPLPRF-02



PPLPRF-T1

SIZE	22.5 mm
BODY	POLYAMIDE
INSERT	ALUMINUM DICASTING
LEVER	SS 304
CHUCKNUT	POLYAMIDE
SCREW	SS 304
GASKET	EPDM

### 💡 WHY PECOx?

- > Salt spray test.

### TECHNICAL DATASHEET / PACKAGING / PRICING

PRODUCT CODE	LIST PRICE (INR)	UNIT	SPECIFICATION	STANDARD PKG	MASTER PKG
PPLRF - 01/02	95.00	No.	PANEL LOCK 22.5 mm	25	600
PPLRF - T1	113.00	No.	KNOB LOCK 22.5 mm	25	600

## PANEL LOCK ACCESSORIES (22.5mm SERIES)



PPLK-U5

PPLKU



PPLPPL1



PPLH



PI01



PRODUCT CODE	LIST PRICE (INR)	UNIT	DESCRIPTION	STANDARD PKG	MASTER PKG
PPLH	7.50	No.	PANEL LOCK PULLING HANDLE	100	3000
PPLPPL1	20.00	No.	PAD LOCK ARRANGEMENT	100	3000
PPLC	20.00	NO.	Ip65 PROTECTION COVER	100	3000
PI01	100.00	No.	OPEN CLOSE LEGEND STICKER	100	2400
PPLK-U	19.00	No.	PANEL KEY U-TYPE FOR PPLP01/02	100	2400
PPLK-U5	21.00	No.	PANEL KEY FOR PPLP05	100	3000



## PANEL LOCK - SNAP FIT

SIZE	22.5 mm
BODY	POLYCARBONATE
INSERT	POLYCARBONATE
LEVER	MS LEVER (CHROME PLATED)
CUTOUT	
GASKET	EPDM

PRODUCT CODE	LIST PRICE (INR)	UNIT	DESCRIPTION	STANDARD PKG	MASTER PKG
--------------	------------------	------	-------------	--------------	------------

## PANEL LOCK 16mm

SIZE	16 mm
BODY	ZINC DIE CASTING
INSERT	ALUMINUM/ZINC PRESS DICASTING
LEVER	MS LEVER (CHROME PLATED)
CHUCKNUT	ZINC ALLOY(CHROME)
GASKET	EPDM



### WHY PECOX?

> Powder Coated With Chrome plating reduces risk of corrosion.

### TECHNICAL DATASHEET / PACKAGING / PRICING

PRODUCT CODE	LIST PRICE (INR)	UNIT	DESCRIPTION	STANDARD PKG	MASTER PKG
PPL-S04	63.00	No.	16mm Lock with chucknut	50	1200
PPL-SC	45.00	No.	Catcher for Lock	50	1200
PPL-SH	20.00	No.	Side handle	100	3000
PPLK-S04	30.00	No.	Key for Lock	100	2400



## CANOPY LOCK & HINGE

MATERIAL	ALUMINUM PRESS DIE-CASTING
COLOR	BLACK

PRODUCT CODE	LIST PRICE (INR)	UNIT	DESCRIPTION	STANDARD PKG	MASTER PKG
PCL01	1010.00	No.	CANOPY LOCK	2	50

## THREE POINT LOCK-METALLIC(PUSH FIT TYPE)

MATERIAL	ALUMINIUM DIE CASTING
COLOR	BLACK



### TECHNICAL DATASHEET / PACKAGING / PRICING

PRODUCT CODE	LIST PRICE (INR)	SPECIFICATION	MOUNTING ACCESSORIES	PAD LOCKING ARRANGEMENT	STANDARD PKG	MASTER PKG
P3PL03	885.00	Without Rod & Accessories	No	No	2	75
P3PL04	1200.00	With Accessories & 2 Nos x 1050mm Rod	Yes	No	2	75
P3PL04-1250	1375.00	With Accessories & 2 Nos x 1250mm Rod	Yes	No	2	75

## THREE POINT LOCK - POLYAMIDE

<b>MATERIAL</b>	ENGINEERING GRADE GLASS FILLED THERMOPLASTIC
<b>ROD TYPE</b>	ROUND RODS
<b>COLOR</b>	BLACK

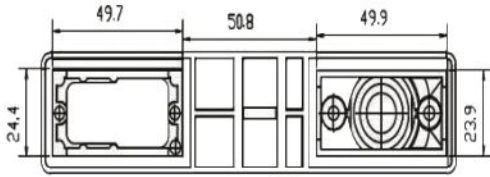

Extended Lever Bolt with 3 lock nuts for adjustment as per door depth



Optional Pad-Locking arrangement



### WHY PECO X?

- > Optional Pad Locking arrangement.
- > Extended Lever - Bolt with extra hardwares, enabling T - Lever to be adjusted as per the depth of the planet.
- > Glass filled Thermoplastic Polymer exhibits better mechanical strength compared to other plastic(PP)

### TECHNICAL DATASHEET

PRODUCT CODE	LIST PRICE (INR)	UNIT	SPECIFICATION	MOUNTING ACCESSORIES	PAD LOCKING ARRANGEMENT	STANDARD PKG	MASTER PKG
P3PL00	338.00	No.	Without Rod & Accessories	No	Yes	2	50
P3PL01	393.00	No.	With Accessories, Without Rod	Yes	Yes	2	50
P3PL02	638.00	No.	With Accessories & 2 No. x 1050mm Rod	Yes	Yes	2	50
P3PL02-1250	705.00	No.	With Accessories & 2 No. x 1250mm Rod	Yes	Yes	2	50



## THREE POINT LOCK - METALLIC

<b>MATERIAL</b>	ALUMINUM DIE CASTING
<b>ROD TYPE</b>	ROUND RODS
<b>COLOR</b>	BLACK

### PACKAGING & PRICING

PRODUCT CODE	LIST PRICE (INR)	SPECIFICATION	MOUNTING ACCESSORIES	PAD LOCKING ARRANGEMENT	STANDARD PKG	MASTER PKG
P3PL10	885.00	Without Rod & Accessories	No	Yes	2	100
P3PL11	950.00	With Accessories & Without Rod	Yes	Yes	2	100
P3PL12	1200.00	With Accessories & 2 Nos x 1050mm Rod	Yes	Yes	2	100

## 3/5 POINT LOCKING-GEAR OPERATED

<b>MATERIAL</b>	ENGINEERING GRADE GLASS FILED THERMOPLASTIC
<b>COLOR</b>	BLACK
<b>ROD TYPE</b>	FLAT RODS

### WHY PECO X?

- > Optional Pad Locking arrangement.
- > An Extended Thumb Grip.



Optional Pad Locking Arrangement

- > Lever - Bolt with extra hardwares, enabling
- > Glass filled Thermoplastic Polymer exhibits better
- > mechanical strength compared to other plastic(PP)

### TECHNICAL DATASHEET

PRODUCT CODE	LIST PRICE (INR)	SPECIFICATION	CATCHERS (NO.)	MOUNTING ACCESSORIES	PAD LOCKING ARRANGEMENT	STANDARD PKG	MASTER PKG
P3PL06	975.00	With Accessories & 2 Nos x 900mm Rod	-	Yes	Yes	5	50
P3PL05	POR	With Accessories & 2 Nos x 900mm Rod	2	Yes	Yes	5	50

## PANEL HINGES

PRODUCT CODE	LIST PRICE (INR)	UNIT	DESCRIPTION	STANDARD PKG	MASTER PKG
PHN-SH40	28.00	Nos	MS Single Hole 40 mm	100	600
PHN-DH40	29.00	Nos	MS Double Hole 40mm	100	600

PRODUCT CODE	LIST PRICE (INR)	UNIT	DESCRIPTION	STANDARD PKG	MASTER PKG
PHN-DH55	33.75	Nos	MS Double Hole 55 mm	100	600
PHN-DH60	49.50	Nos	MS Double Hole 60 mm	50	300
PHN-DH-90	88.55	Nos	MS Double Hole 90 mm	50	300

PRODUCT CODE	LIST PRICE (INR)	UNIT	DESCRIPTION	STANDARD PKG	MASTER PKG
PHN-DB1	32.50	Nos	MS DB Hinge	100	1000

PRODUCT CODE	LIST PRICE (INR)	UNIT	DESCRIPTION	STANDARD PKG	MASTER PKG
PHNU20	23.00	Nos	MS U Type Hinge for 20 mm Depth	50	1000
PHNU25	25.30	Nos	MS U Type Hinge for 25 mm Depth	50	1000

PRODUCT CODE	LIST PRICE (INR)	UNIT	DESCRIPTION	STANDARD PKG	MASTER PKG
PHNUS	34.50	Nos	MS U Type Hinge for 20 mm Depth	50	1000

PRODUCT CODE	LIST PRICE (INR)	UNIT	DESCRIPTION	STANDARD PKG	MASTER PKG
PHN-DB2	28.00	Nos	Die Casted Male / Female DB Hinge	100	1000

PRODUCT CODE	LIST PRICE (INR)	UNIT	DESCRIPTION	STANDARD PKG	MASTER PKG
PHN-05	52.00	Nos	Die Casted Concealed Hinge	50	1000

PRODUCT CODE	LIST PRICE (INR)	UNIT	DESCRIPTION	STANDARD PKG	MASTER PKG
PHN-37	152.00	Nos	Die Casted Consealed Hinge 75mm	20	300

PRODUCT CODE	LIST PRICE (INR)	UNIT	DESCRIPTION	STANDARD PKG	MASTER PKG
PHN-19S0SS	449.00	Nos	Stainless Steel with Square hole	10	200

**Material - MS Zinc passivized**  
**Description - Concealed Hinge**



**Material - MS Zinc passivized**  
**Description - U-type Hinge**



**Material - Zinc Die Casted**



## DIN RAIL CHANNELS & CUTTER



PDRC



PDRCM

MATERIAL	COLD ROLLED STEEL
GASKET	WHITE
COLOR	ELECTRO PLATING 'TRIVELLENT BLUE'

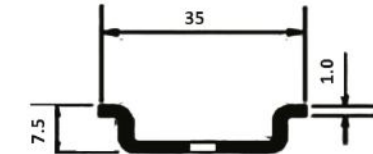

PMCHSW3575

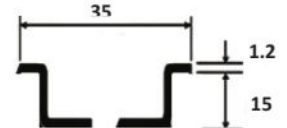

PMCHSW3515

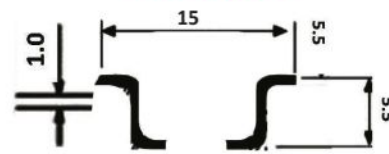

PMCHSW1555

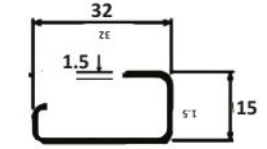

PTBCHSW3215

### WHY PECOX?

> Accurate Thickness as per industry standards.

### TECHNICAL DATASHEET

PRODUCT CODE	LIST PRICE (INR)	UNIT	DESCRIPTION	SPECIFICATION (mm)	STANDARD PKG
PMCHSW3575	112.50	Mtr	MCB Mounting Channel	35 x 7.5 x 1	100
PMCHSW357509	99.00	Mtr	MCB Mounting channel - ECO	35 x 7.5 x 0.9	100
PMCHSW3575N	120.00	Mtr	Easy Cut MCB Mounting channel	35. x 7.5 x 1	100
PMCHSW351512	210.00	Mt	Deep MCB Mounting Channel - ECO	35 x 15 x 1.2	50
PMCHSW351515	228.00	Mtr	Contactora/ MCB Mounting Channel	35 x15 x 1.5	50
PMCHSW1555	78.50	Mtr	Micro Channel	15 x 5.5 x 1	100
PTBCHSW321512	192.00	Mtr	Terminal Block Channel - ECO	32 x15 x 1.2	50
PTBCHSW321515	234.00	PC	Terminal Block Channel	32 x15 x 1.5	50
PDRC	84000.00	PC	Universal Din Rail Cutting Tool	-	1
PDRCM	35000.00	PC	Din RailCutter for PMCHSW3575	-	1

## END CLAMPS/STOPPER/SHROUDS

MATERIAL ENGINEERING GRADE THERMOPLASTIC



### WHY PECOX?

> Range of Stoppers provides a Cost Advantages keeping the quality intact.



PSCUN



PECP



PSCKN



PSCS



PSCKNMLH



PTBS1

PRODUCT CODE	LIST PRICE (INR)	UNIT	DESCRIPTION	STANDARD PKG	MASTER PKG
PSCUN	12.00	No.	Polyamide Stopper (Suitable for C&G Channel)	100	2600
PECP	9.40	No.	Polyamide Stopper (Suitable for C&G Channel)	100	2400
PSCKN	8.00	No.	Polyamide Stopper Suitable for 'C' (MCB) Channel	100	4000
PSCS	7.50	No.	MS Stopper Suitable for 'G' / Terminal Block Channel	100	2000
PSCKNMLH	20.00	No.	Polymide Stopper for Marking Holder & Shroud	100	4000
PTBS1	70.00	No.	Polycarbonate Shroud	100	2000

## SNAP FIT GROMMETS

<b>MATERIAL</b>	ENGINEERING GRADE THERMOPLASTIC
<b>COLOR</b>	RAL7035(GREY)
<b>GASKET</b>	EPDM



### WHY PECOX?

- > It's Open & Close type grommet, with optional center knocout
- > Ip54 degree protection.

- > Compatible with both 1.6mm & 2mm thick Panel Sheet.
- > No-"Wear&Tear" due to environment as compared to rubber grommet.

### PACKAGING & PRICING

PRODUCT CODE	LIST PRICE (INR)	UNIT	SUITABLE FOR HOLE DIA (mm)	STANDARD PKG	MASTER PKG
PGS10	3.00	Nos	10	500	20000
PGS22	6.00	Nos	22	100	5000
PGS25	6.00	Nos	25	100	5000
PGS32	6.50	Nos	32	100	2500
PGS38	7.50	Nos	38	100	2000
PGS50	10.00	Nos	50	100	1000



### WHY PECOX?

- > Thermo-Elastic material has a properly to reshape and compressed down post the wire is inserted making the panel dust and proof.

## POLY-ELASTIC GROMMENTS

<b>MATERIAL</b>	ENGINEERING GRADE THERMOPLASTIC
<b>COLOR</b>	BLACK/ORANGE

### PACKAGING & PRICING

PRODUCT CODE	LIST PRICE (Rs)	UNIT	SUITABLE FOR HOLE DIA (mm)	STANDARD PKG(NO.)	MASTER PKG(NO.)
PGR 38	PDR	Nos	38	100	2000

## SELF ADHESIVE FOAM GASKET

<b>MATERIAL</b>	EVA FOAM
<b>COLOR</b>	BLACK
<b>ADHESIVE</b>	STRONG COMPOUNDED ADHESIVE



### WHY PECOX?

- > Strong Adhesive.

### PACKAGING & PRICING

PRODUCT CODE	LIST PRICE (INR)	UNIT	SIZE (mm)	STANDARD PKG	MASTER PKG	PRODUCT CODE	LIST PRICE (INR)	UNIT	SIZE (mm)	STANDARD PKG	MASTER PKG
PAG0310	36.20	Roll=10 mtr	10 x 3	30	360	PAG0330	108.60	Roll=10 mtr	30 x 3	10	120
PAG0312	43.21	Roll=10 mtr	12 x 3	30	360	PAG0340	145.12	Roll=10 mtr	40 x 3	7	84
PAG0315	53.73	Roll=10 mtr	15 x 3	15	180	PAG0518	50.28	Roll=5 mtr	18 x 5	15	180
PAG0318	65.38	Roll=10 mtr	18 x 3	15	180	PAG0520	58.46	Roll=5 mtr	20 x 5	15	80
PAG0320	72.40	Roll=10 mtr	20 x 3	15	180	PAG0525	69.53	Roll=5 mtr	25 x 5	12	144
PAG0325	90.49	Roll=10 mtr	25 x 3	12	144	PAG0540	111.55	Roll=5 mtr	40 x 5	7	84

## PANEL DOOR HANDLES



PDH-1



PDH

### WHY PECOX?

- > Insert have been provide to have an inter-locking.
- > Designed for proper griping & handling.



PDH90

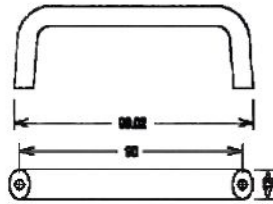

### MATERIAL

ENGINEERING GRADE  
THERMOPLASTIC

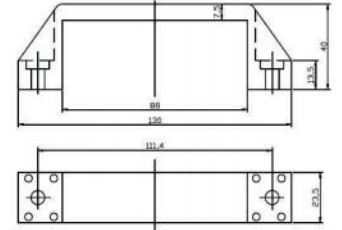
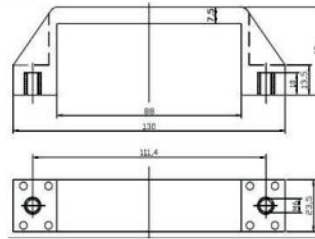

### TECHNICAL DATASHEET / PACKAGING / PRICING

PRODUCT CODE	LIST PRICE (INR)	UNIT	DESCRIPTION	MOUNTING DIMENSIONS C-C (mm)	STANDARD PKG	MASTER PKG
PDH	31.00	Nos	HANDLE WITHOUT INSERT	111.4	40	480
PDH-I	47.00	Nos	HANDLE WITH INSERT	111.4	40	480
PDH90	13.00	Nos	CABINET HANDLE	90	100	1200

## POCKET HANDLES

MATERIAL	SNAP FIT POCKET HANDLE (FLUSH)
GASKET	BLACK & GREY(RAI7035)
COLOR	EPDM

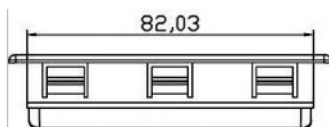
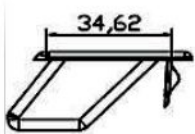

### WHY PECOX?

- > EPDM Gasket to maintain Ip54 degree protection.
- > Extra depth for perfect griping.

### PACKAGING & PRICING

PRODUCT CODE	LIST PRICE (INR)	UNIT	CUTOUT SIZE (mm x mm)	COLOR	STANDARD PKG	MASTER PKG
PDPH	22.00	Nos	82.03x34.62	GREY	40	480
PDPHN	22.00	Nos	82.03x34.62	BLACK	40	480



### WHY PECOX?

- > Finger Contacts can be used as SPREADER LINK for Input connections from the Bus Bars/MCB/CONTACTORS to control circuit with help of snap type lugs.

## FINGER CONTACT

### MATERIAL

BRASS (TINNED PLATED)

### PACKAGING & PRICING

PRODUCT CODE	LIST PRICE (INR)	UNIT	NO. OF WAYS	MOUNTING HOLES	STANDARD PKG	MASTER PKG
PFC02	20.50	Nos	2	M8	100	NA
PFC03	23.10	Nos	3	M12	100	NA



## SCREW KNOB

<b>MATERIAL</b>	POLYAMIDE HEAD WITH MST (ZINC PLATED) MOULDED
<b>THREADING</b>	
<b>LOCKING WASHER</b>	PVC



### WHY PECO X?

- > Screw Knobs are moulded with Hexagonal Bolt to provide perfect grip (No Threaded Rod is used).
- > A unique designed PVC Washer is provided which can scale up & down easily.

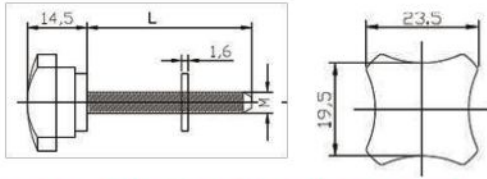

### TECHNICAL DATASHEET / PACKAGING / PRICING

PRODUCT CODE	LIST PRICE (INR)	UNIT	BOLT SIZE	BOLT LENGTH	STANDARD PKG	MASTER PKG
PSK625	8.40	Nos	M6	25	100	3000
PSK632	8.80	Nos	M6	32	100	2600
PSK638	9.53	Nos	M6	38	100	2600
PSKS225	8.40	Nos	2 SOOT	25	100	3000
PSKS232	8.80	Nos	2 SOOT	32	100	2600

## LIFTING HOOK



<b>MATERIAL</b>	MS SHEET (ZINC PASSIVATED)
<b>MOUNTING</b>	CORNERS OF PANEL-FRAME L-SHAPE - CENTRE OF PANEL-FRAME

### WHY PECO X?

- > A unique design, well tested to have a breaking load at 20.8 KN by Spectro Lab.
- > Mounting washers are provided for proper fastening.

- > L-Shape is also provided for mounting in centre to the frame, if required.

### TECHNICAL DATASHEET / PACKAGING / PRICING

PRODUCT CODE	LIST PRICE (Rs)	UNIT	SHEET THICKNESS (mm)	SPECIFICATION	MOUNTING HOLES DIA(mm)	STANDARD PKG	MASTER PKG
PLH50/PLH50L	91.25	Nos	5	50	19KN	20	120
PLH38/PLH38L	71.60	Nos	4	38		30	180
PLH25/PLH25L	56.60	Nos	3	25		40	240

## POWER TERMINAL BLOCKS

<b>MATERIAL</b>	ENGINEERING GRADE GLASS FILLED THERMOPLASTIC
-----------------	---



### WHY PECO X?

- > Power Terminal Blocks are made up of "Glass filled thermoplastic to ensure higher strength, & better creepage distance.

- > Uniquely Designed for universal mounting on both Din Rails And also on Surface.

### TECHNICAL DATASHEET / PACKAGING / PRICING

PRODUCT CODE	LIST PRICE (INR)	UNIT	FOR WIRE SIZE UPTO (sqmm)	CURRENT RATING	BOLT SIZE	STANDARD PKG	MASTER PKG
PTB50BP	POR	Nos	50	150 Amps	M6	20	200
PTB70BP	POR	Nos	70	192 Amps	M6	20	200
PTB94BP	POR	Nos	95	250 Amps	M10	20	200



## NEUTRAL LINK - BASE MOUNTING

<b>BODY</b>	ENGINEERING GRADE FILLED THERMOPLASTIC
<b>CONTACTS</b>	BRASS
<b>COLOR</b>	RED & BLACK



PNL 125

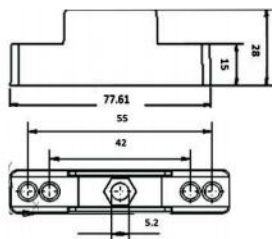

PNL32

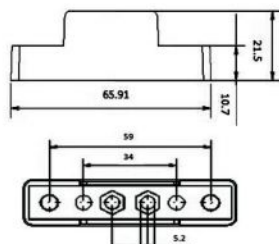

PNL63

### WHY PECOX?

- > PNL16/32/63, Uniqually designed with extended side guards so that the sliding bar do not short to other links during operation.
- > No Current leakage since Glass filled Thermoplastic is adverse to moisture or humidity.
- > Double hole mounting also available in 16A & 32A.

## TECHNICAL DATASHEET / PACKAGING / PRICING

PRODUCT CODE	LIST PRICE (INR)	UNIT	CURRENT RATING	BOLT SIZE	STANDARD PKG	MASTER PKG
PNL16	45.00	Nos	16 Amps	M5	60	1020
PNL16DH	47.00	Nos	16 Amps	M5	60	1020
PNL32	47.00	Nos	32 Amps	M5	60	1020
PNL32DH	53.00	Nos	32 Amps	M5	60	1020
PNL63	138.00	Nos	63 Amps	M5	30	450
PNL125	225.50	Nos	125 Amps	M6	20	300
PNL150	POR	Nos	150 Amps	M6	20	100
PNL250	POR	Nos	250 Amps	M6	20	100



PKNL32



PKNL63

### WHY PECOX?

- > A new concept replacing the traditional design, reducing the the labour cost & time by simply masking snapfit on din rails.
- > PKNL125-250 have additional Unique Feature of universal mounting arrangement on both rails also on surface.

## NEUTRAL LINK-CHANNEL MOUNTING

<b>BODY</b>	ENGINEERING GRADE THERMOPLASTIC
<b>COLOR</b>	BLACK
<b>CONTACT</b>	BRASS



PKNL 125/200/250

## PACKAGING & PRICING

PRODUCT CODE	LIST PRICE (INR)	UNIT	CURRENT CAPACITY	SPECIFICATION	STANDARD PKG	MASTER PKG
PKNL16	47.50	Nos	16	BRASS	50	800
PKNL32	49.00	Nos	32	BRASS	50	800
PKNL63	130.00	Nos	63	BRASS	30	480
PKNL125	POR	Nos	125	BRASS	10	200
PKNL200	POR	Nos	200	BRASS	10	200
PKNL250	POR	Nos	250	BRASS	10	200



## NEUTRAL LINK BARS

<b>MATERIAL</b>	ENGINEERING GRADE GLASS FILLED THERMOPLASTIC
-----------------	--

### CURRENT RATING: 16-32 AMPS

PRODUCT CODE	LIST PRICE (INR)	SCREW SIZE	NUMBER OF WAYS	STANDARD PKG
PELB163205	22.90	M3	5	100
PELB163207	32.00	M3	7	100
PELB163209	41.19	M3	9	100
PELB163213	59.56	M3	13	100
PELB163217	77.78	M3	17	100

### CURRENT RATING: 32 AMPS

PRODUCT CODE	LIST PRICE (INR)	SCREW SIZE	NUMBER OF WAYS	STANDARD PKG
PELB3205	43.97	M4	5	50
PELB3207	61.56	M4	7	50
PELB3209	79.17	M4	9	50
PELB3213	114.38	M4	13	50
PELB3217	149.58	M4	17	50
PELB3237	325.61	M4	37	50

### CURRENT RATING: 63 AMPS

PRODUCT CODE	LIST PRICE (INR)	SCREW SIZE	NUMBER OF WAYS	STANDARD PKG
PELB6309	126.76	M5	9	50
PELB6313	183.12	M5	13	50
PELB6317	239.34	M5	17	50
PELB6337	520.52	M5	37	20

### CURRENT RATING: 100 AMPS

PRODUCT CODE	LIST PRICE (INR)	SCREW SIZE	NUMBER OF WAYS	STANDARD PKG
PELB10013	343.70	M6	13	20
PELB10017	448.06	M6	17	20
PELB10037	976.83	M6	37	20

## NEUTRAL BASE

<b>MATERIAL</b>	ENGINEERING GRADE GLASS FILLED THERMOPLASTIC
<b>COLOR</b>	RED, WHITE & BLACK



PELB-B2



PELB-3810

### PACKAGING & PRICING

PRODUCT CODE	LIST PRICE (INR)	UNIT	SUITABILITY	MOUNTING HOLE	STANDARD PKG	MASTER PKG
PELB-B2	7.90	Nos	For 32-100 Amps NEUTRAL BAR	M4	100	3000
PELB-3810	9.00	Nos	For 16/32 Amps NEUTRAL BAR	M4	100	9000

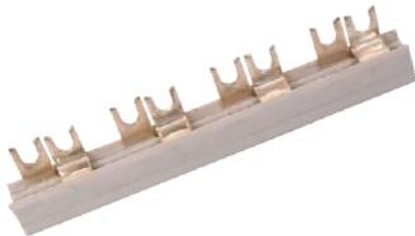

## MCB COMBED BUS BARS

<b>CONTACTS</b>	ELECTROLYTIC COPPER
<b>PLATING</b>	TINNED COPPER PLATED
<b>INSULATION</b>	PVC
<b>COLOR</b>	LIGHT GREY
<b>CURRENT</b>	63 Amps

### WHY PECO?

- > Comb bus bars are tinned plated to prevent from oxidization.
- > Electrolytic Grade of Copper provide better conductivity.
- > Pvc Insulation Provide Protection form any shock & unforeseen events.

### PACKAGING & PRICING

PRODUCT CODE	LIST PRICE (INR)	UNIT	TYPE OF MCB	NO. OF MCB SHORTING	STANDARD PKG	PRODUCT CODE	LIST PRICE (INR)	UNIT	TYPE OF MCB	NO. OF MCB SHORTING	STANDARD PKG
PMSP-P	1191.45	MTR	SP	57	50	PMTP-P/U	3579.65	MTR	TP	19	20
PMSP-U	1245.60	MTR	SP	57	50	PMFP-P/U	4602.40	MTR	FP	14	12
PMDP-P/U	2246.35	MTR	DP	28	24						

# STANDARD CONNECTION PATES

<b>MATERIAL</b>	ENGINEERING GRADE GLASS FILLED THERMOPLASTIC
<b>COLOR</b>	BASE-WHITE COVER-TRANSPARENT(CLEAR) CAPS-AS PER INTERNATIONAL STANDARDS

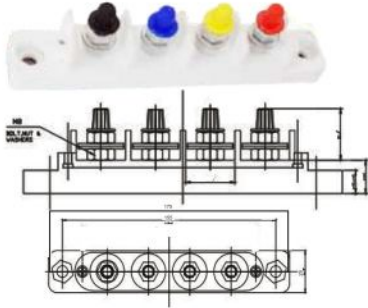

**PTPN100**

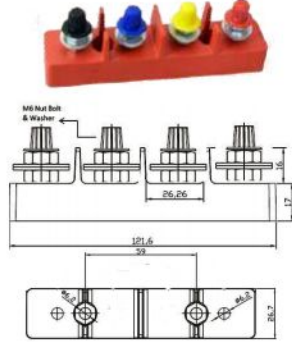

**PTPN63/PKTPN63**

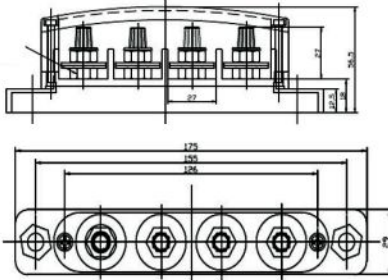

**PTSB6**

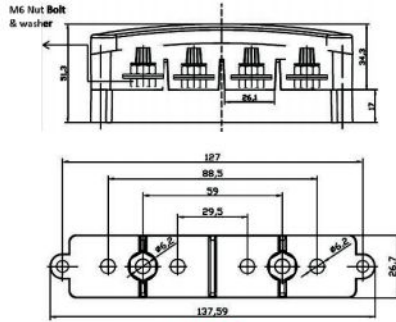

**PTSB4**

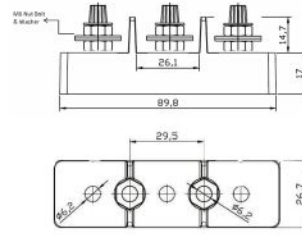

**PTP63**

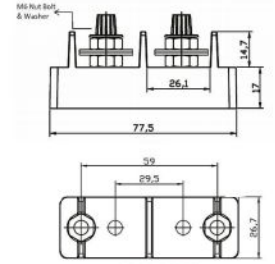

**PDP63**

## WHY PECOX?

- > No current leakage since Glass filled Thermoplastic is adverse to moisture or humidity.
- > Glass filled material exhibits excellent mechanical strength making it more rigid & strong.
- > Balanced mounting design avoids breakage due to weight of cable.
- > Hexagonal mounting arrangements speeds up the fixing/ mounting process.
- > Polycarbonate Protection Cover is unbreakable & UV Stabilized.

## PACKAGING & PRICING

PRODUCT CODE	LIST PRICE (INR)	CURRENT RATING	SCREW SIZE	NUMBER OF POLES	PROTECTIO COVER	MOUNTING HOLES (C-C)	STANDARD PKG	MASTER PKG
PDP63	55.00	63 Amps	M6	2	NO	59	50	600
PTP63	62.00	63 Amps	M6	3	NO	29.5	45	540
PTPN63	73.00	63 Amps	M6	4	NO	59	30	360
PKTPN63	54.00	63 Amps	M6	4	NO	59	30	360
PTSB4C	110.00	63 Amps	M6	4	YES	59	15	180
PTSB4P	123.00	63 Amps	M6	4	YES	59	15	180
PTPN100	112.00	100 Amps	M8	4	NO	155	7	210
PTSB6C	154.00	100 Amps	M8	4	YES	155	5	140
PTSB6P	167.00	100 Amps	M8	4	YES	155	5	140



## INDICATING LIGHTS - FLAT TYPE

BODY	ENGINEERING GRADE THERMOPLASTIC
LENS	DIFFUSE POLYCARBONATE
SIZE	22.5 mm SERIES

### WHY PECOX?

> PICL - 22M Provides Multi-voltage option, reducing inventory.

### PACKAGING & PRICING

PRODUCT CODE	LIST PRICE (INR)	UNIT	VOLTAGE	COLOR	STANDARD PKG	MASTER PKG
PIL22	60.00	Nos	220V AC	R/Y/B/G/W/Amber	10	500
PIL22 MV	POR	Nos	MULTI VOLTAGE	R/Y/B/G/W/Amber	10	500

## INDICATING LIGHTS - DOME TYPE

BODY	ENGINEERING GRADE THERMOPLASTIC
LENS	DIFFUSE POLYCARBONATE
SIZE	22.5 mm SERIES



### PACKAGING & PRICING

PRODUCT CODE	LIST PRICE (INR)	UNIT	VOLTAGE	COLOR	STANDARD PKG	MASTER PKG
PIL22D	60.00	Nos	220V AC	R/Y/B/G/W/Amber	10	500
PL22D MV	POR	Nos	MULTI VOLTAGE	R/Y/B/G/W/Amber	10	500



## INDICATING LIGHTS - SCREW LESS

BODY	ENGINEERING GRADE THERMOPLASTIC
LENS	DIFFUSE POLYCARBONATE
SIZE	22.5 mm SERIES

### PACKAGING & PRICING

PRODUCT CODE	LIST PRICE (INR)	UNIT	VOLTAGE	COLOR	STANDARD PKG	MASTER PKG
PIL22SL	POR	Nos	220V AC	R/Y/B/G	10	500

## HRC FUSE HOLDER

MATERIAL	ENGINEERING GRADE GLASS FILLED THERMOPLASTIC
FIXED CONTACT	BRASS
MOVING CONTACT	PHOSPHOROUS BRONZE (Pb)



### WHY PECOX?

- > "Pb contact" exhibits better spring action.
- > "Glass Filled Polyamide" adverse to moisture thus "Zero Current Leakage".

### PACKAGING & PRICING

PRODUCT CODE	LIST PRICE (INR)	UNIT	CURRENT RATING (Amps)	STANDARD PKG	MASTER PKG
PFH2032	140.80	Nos	20-32	15	300

## CONICAL BUS BAR SUPPORTS

<b>MATERIAL</b>	ENGINEERING GRADE GLASS FILLED THERMOPLASTIC
<b>INSERTS</b>	MS (HEXAGONAL GROOVED) & BRASS
<b>COLOR</b>	RED



### WHY PECOx?

- > Glass filled Thermoplastic exhibits better mechanical & Dielectric strength making it more rigid and strong as compared to Thermoset material.
- > No current leakage Since Glass filled Thermoplastic is adverse to moistures or humidity.
- > Hexagonal Multi Grooved inserts accelerates better griping as compared to round ones.
- > Insert Pull Out at force of 5.6KN, tested by Spectro labcalibrated at 50 ton U.T.M.
- > 3 CPRI - 3.3 KV tested.

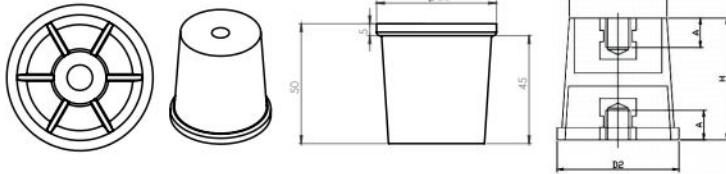

### ECO SERIES

### TECHNICAL DATASHEET/ PRICING/ PACAGING

PRODUCT CODE	LIST PRICE (INR)	UNIT	MATERIAL	D1	DIMENSION			INSERT THREAD LENGTH (A) (mm)		STANDARD PKG	MASTER PKG
					D2	H					
PKBI630C**	19.50	Nos	PBT G/F	25	30	30	M6	10	60	1800	
PKBI840C**	32.50	Nos	PBT G/F	33	40	40	M8	12	60	960	
PKBI1050C**	50.00	Nos	PBT G/F	40	50	50	M10	14	60	360	

### PREMIUM SERIES

### TECHNICAL DATASHEET/ PRICING/ PACAGING

PRODUCT CODE	LIST PRICE (INR)	UNIT	MATERIAL	D1	DIMENSION			INSERT THREAD LENGTH (A) (mm)		STANDARD PKG	MASTER PKG
					D2	H					
PBI630CN	23.75	Nos	NYLON 6 G/F	25	30	30	M6	10	60	1800	
PBI840CN	44.00	Nos	NYLON 6 G/F	33	40	40	M8	12	60	960	
PBI1050CN	78.00	Nos	NYLON 6 G/F	40	50	50	M10	14	60	360	



FR LS ZH

## HEXAGONAL BUS BAR SUPPORTS

<b>MATERIAL</b>	ENGINEERING GRADE FILLED THERMOPLASTIC
<b>INSERTS</b>	MS(HEXAGONAL-MULTI- GROOVED)
<b>COLOR</b>	WHITE

### WHY PECOx?

- > Glass filled Thermoplastic exhibits mechanical & Dielectric strength making it more rigid and strong as compared to Thermoset material.
- High Voltage 3.3KV Passed & Tested by CPRI, Noida Report
- > No- CPRI RT LHV2017 T102.

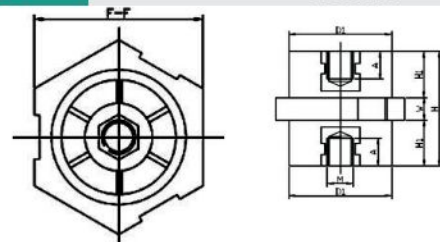

### TECHNICAL DATASHEET/ PRICING/ PACAGING

PRODUCT CODE	LIST PRICE (INR)	UNIT	D1	DIMENSION				INSERT THREAD LENGTH (A) (mm)		STANDARD PKG	MASTER PKG
				(FF)	H	H1	W				
PBI415H	25.00	Nos	11.5	14	15	5.5	4	M4	5	100	2000
PBI630H	35.00	Nos	26	30	30	11	8	M6	10	50	1500
PBI830H	45.00	Nos	26	30	30	11	8	M8	12	50	1500
PBI840H	62.50	Nos	40	45	40	15	9.5	M8	12	45	540
PBI1050H	90.00	Nos	40	50	50	20	10	M10	14	60	360

NOTE : FR MATERIAL ALSO AVAILABLE FOR ALL BUS BAR SUPPORT @ 30% EXTRA ON LIST PRICE



## P-SERIES BUS BAR SUPPORTS

<b>MATERIAL</b>	ENGINEERING GRADE GLASS FILLED THERMOPLASTIC
<b>INSERTS</b>	MS (MULTI GROOVED-HEXAGONAL)
<b>COLOR</b>	OFF-WHITE

### WHY PECOX?

- > Based on the fundamental of Civil & Electrical engineering.
- > It can be fitted/tighten well with the Spanners.
- > Glass filled Thermoplastic exhibits excellent mechanical & Dielectric strength making it more rigid and strong
- No current leakage Since Glass filled Thermoplastic is adverse to moisture or humidity.

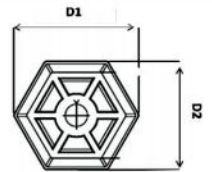
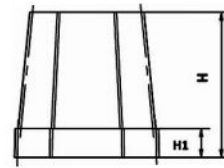

### TECHNICAL DATASHEET/ PRICING/ PACAGING

PRODUCT CODE	LIST PRICE (INR)	UNIT	D1	D2	H1	H	INSERT SIZE	INSERT LENGTH	SUGGESTED SPANNER SIZE	STANDARD PKG	MASTER PKG
PBI415P	25.80	Nos	14	13	4	15	M4	5	NA	100	2000
PBI625P	32.25	Nos	25	22	6	25	M6	8	26	60	1680
PBI630P	32.25	Nos	29	26	6	30	M6	8	26	60	1680
PBI830P	43.00	Nos	29	26	6	30	M8	10	36	60	1680
PBI840P	48.35	Nos	41	36	8	40	M8	10	36	45	540
PBI1050P	80.00	Nos	50	43	10	50	M10	12	NA	60	300

## L SUPPORT

<b>MATERIAL</b>	ENGINEERING GRADE GLASS FILLED THERMOPLASTIC
<b>COLOR</b>	OFF WHITE(NATURAL)

### WHY PECOX?

- > L - Support are Uniquely designed with mounting hole on the base & two holes have provision & side for easy & standard mounting.

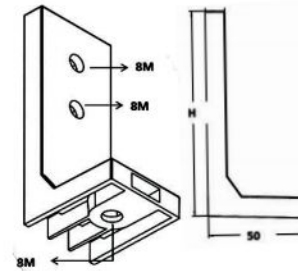

### PACKAGING & PRICING

PRODUCT CODE	LIST PRICE (INR)	UNIT	SPECIFICATION H (mm)	MOUNTING HOLE	STANDARD PKG	MASTER PKG
PLS85	40.40	Nos	85	M8	40	480
PLS105	52.50	Nos	105	M8	40	480
PLS125	60.90	Nos	125	M8	40	480



## GRIP TYPE SUPPORT (SNAP-FIT-TYPE)

<b>MATERIAL</b>	ENGINEERING GRADE GLASS FILLED THERMOPLASTIC
<b>COLOR</b>	OFF WHITE(NATURAL)

### WHY PECOX?

- > Glass filled Thermoplastic exhibits excellent mechanical & Dielectric strength making it more rigid & strong.
- > Snap Fit design Saves Labour Cost.

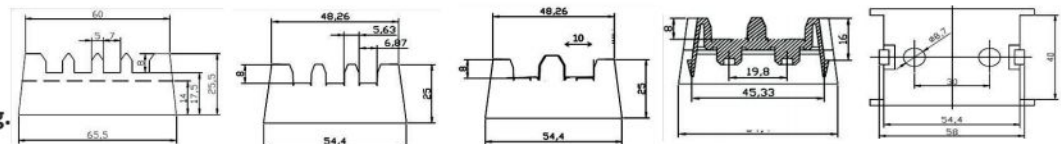

### TECHNICAL DATASHEET/ PRICING/ PACAGING

PRODUCT CODE	LIST PRICE (INR)	UNIT	SPECIFICATION	MOUNTING DIMENSIONS HOLE (C TO C) mm	SLOTS (C TO C) mm	STANDARD PKG	MASTER PKG
PAGP407	43.30	Nos	6mm x 4 run	30	54.4	60	720
PAGP307	40.40	Nos	6mm x 3 run	20	45.3	60	720
PAGP210	40.40	Nos	10mm x 2 run	20	45.3	60	720

**NOTE : FR MATERIAL ALSO AVAILABLE FOR ALL BUS BAR SUPPORT @ 30% EXTRA ON LIST PRICE**



# BUS BAR FINGER SUPPORT

<b>MATERIAL</b>	ENGINEERING GRADE GLASS FILLED THERMOPLASTIC
<b>COLOR</b>	WHITE

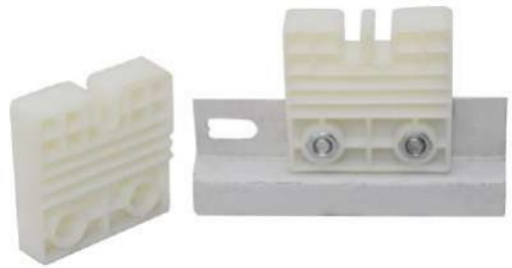

## TECHNICAL DATESHEET PACKAGING & PRICING

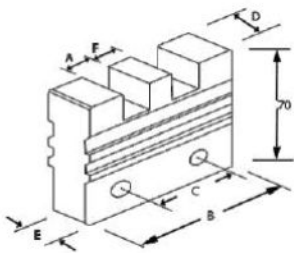
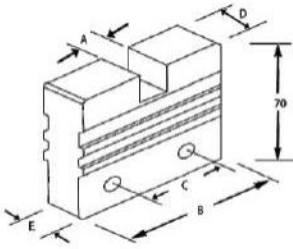

PRODUCT CODE	LIST PRICE (INR)	UNIT	DIMENSION									STANDARD PKG	MASTER PKG
			A	B	C	D	E	F	G	H	I		
PFS-1106K	60.00	Nos	7	70	40	20	20	NA		70	20	500	
PFS-1110K	60.00	Nos	11	70	40	20	20	NA		70	20	500	
PFS-1112K	60.00	Nos	13.5	70	40	20	20	NA		70	20	500	
PFS-1206K	60.00	Nos	7	70	40	20	20	5.6		70	20	500	
PFS-1210K	60.00	Nos	11	70	40	20	20	9		70	20	500	
PFS-1212K	60.00	Nos	13.5	70	40	20	20	11		70	20	500	
PFS-1306K	60.00	Nos	7	70	40	20	20	5.4		70	20	500	
PFS-3310K	110.00	Nos	11	130	80	20	20	8.6		70	10	500	
PFS-3312K	110.00	Nos	13.5	130	80	20	20	11		70	10	500	
PFS-2406K	110.00	Nos	7	130	80	20	20	5.6		70	10	500	
PFS-3410K	110.00	Nos	11	130	80	20	20	9.6		70	10	500	
PFS-3412K	110.00	Nos	13.5	130	80	20	20	11.6		70	10	500	



## SINGLE POLE SUPPORT SYSTEM

<b>MATERIAL</b>	ENGINEERING GRADE GLASS FILLED THERMOPLASTIC
<b>COLOR</b>	OFF WHITE(NATURAL), RED, BLACK, YELLOW, BLUE

### WHY PECO?

- > Glass filled Thermoplastic exhibits excellent mechanical & Dielectric strength making it more rigid and strong as compared to Thermoset material.
- > No current leakage Since Glass filled Thermoplastic is adverse to moisture or humidity.
- > Hexagonal Mounting Arrangements.

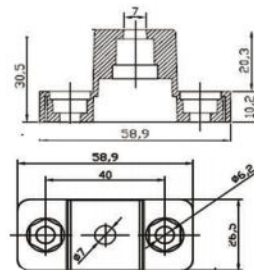

PSP-30

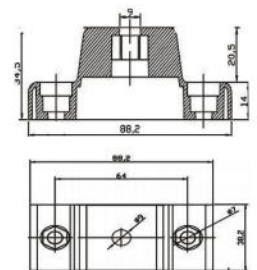

PSP-35

## PACKAGING & PRICING

PRODUCT CODE	LIST PRICE (INR)	UNIT	SPECIFICATION	STANDARD PKG	MASTER PKG
PSP30 R/Y/B/BLK	10.00	Nos	Single Support 30mm Height (Red/yellow/Blue/Black)	90	1680
PSP30 W	14.00	Nos	Single Support 30mm Height (Natural Color)	90	1680
PSP35 R/Y/B/BLK	22.50	Nos	Single Support 35mm Height (Red/yellow/Blue/Black)	70	350
PSP35 W	30.00	Nos	Single Support 35mm Height (Natural Color)	70	350

NOTE : FR MATERIAL ALSO AVAILABLE FOR ALL BUS BAR SUPPORT @ 30% EXTRA ON LIST PRICE



## WIRE SLEEVES/ TUBE

MATERIAL	PVC
COLOR	RED/ YELLOW/ BLUE/ BLACK

### WHY PECOx?

- > Flame Retardant grade V2 tested by Spectro Labs RoHS No.N180530010.

### TECHNICAL DATASHEET

PRODUCT CODE	LIST PRICE (INR)	I.D (mm)	WALL THICKNESS (mm)	SUITABLE FOR WIRE (sqmm)	UNIT (Per Roll)	MASTER PKG
PWS3	118.50	3	0.35	1/1.5 sqmm	30 Mtr	-
PWS3.5	124.74	3.5	0.35	1.5 sqmm	30 Mtr	-
PWS4	137.21	4	0.35	2.5sqmm	30 Mtr	-
PWS5	174.64	5	0.35	4sqmm	30 Mtr	-
PWS6	218.30	6	0.4	6sqmm	30 Mtr	-
PWS7	293.14	7	0.45	10sqmm	30 Mtr	-
PWS8	349.27	8	0.45	16sqmm	30 Mtr	-
PWS9	417.88	9	0.5	16/25 sqmm	30 Mtr	-
PWS10	461.88	10	0.55	25 sqmm	30 Mtr	-
PWS11	548.86	11	0.55	25/35 sqmm	30 Mtr	-
PWS12	611.23	12	0.65	35 sqmm	30 Mtr	-
PWS13	686.07	13	0.65	35/50 sqmm	30 Mtr	-
PWS14	785.86	14	0.65	50 sqmm	30 Mtr	-
PWS15	866.94	15	0.65	70 sqmm	30 Mtr	-
PWS16	904.37	16	0.65	70 sqmm	30 Mtr	-

## FERRULING SLEEVES/TUBE

MATERIAL	PVC
COLOR	WHITE/YELLO(OPTIONAL)

### WHY PECOx?

- > Flame Retardant grade V2 tested by spectro Labs RoHS No. N180530010.
- > Box Packing refrains sleeves from being tangled & protects from dust & other particles.
- > Ferruling Sleeves Comply to RoHS directives.



### PACKAGING & PRICING

PRODUCT CODE	LIST PRICE (INR)	UNIT	DESCRIPTION	STANDARD PKG	MASTER PKG
PPT2.5	468.00	MTR	Suitable for 0.5 sqmm wire	100 Mtr	22
PPT3.2	525.00	MTR	Suitable for 0.75/1.0 sqmm wire	100 Mtr	22
PPT3.5	548.00	MTR	Suitable for 1/1.5 sqmm wire	100 Mtr	22
PPT4.2	675.00	MTR	Suitable for 2.5 sqmm wire	100 Mtr	22
PPT5.2	752.00	MTR	Suitable for 4 sqmm wire	100 Mtr	22
PPT5.5	838.00	MTR	Suitable for 4/6 sqmm wire	100 Mtr	22
PPT6	582.00	MTR	Suitable for 6 sqmm wire	50 Mtr	22
PPT7	901.00	MTR	Suitable for 10 sqmm wire	50 Mtr	22

# HEAT SHRINKABLE BUS BAR SLEEVES



<b>MATERIAL</b>	PVC
<b>THICKNESS</b>	160 TO 170 MICRONS
<b>COLOR</b>	RED/YELLOW/BLUE/BLACK/GREEN

## WHY PECOX?

- > Heat Shrinkable Bus Bar Sleeves Complies to RoHS directives tested by SGS.

## PACKAGING & PRICING

PRODUCT CODE	LIST PRICE (Rs)	UNIT	SUITABLE FOR BUS BAR (sqmm)	LAY FLAT SIZE In mm	STANDARD PACKING
PHS 20	10.80	Per Mtr	12x3, 10x6	20	50 Mtr
PHS 25	10.64	Per Mtr	15x3, 12x6	25	50 Mtr
PHS 30	12.03	Per Mtr	20x3, 18x6, 16x3	30	50 Mtr
PHS 35	12.34	Per Mtr	25x3, 20x6	35	50 Mtr
PHS 41	14.19	Per Mtr	25x6, 25x9	41	50 Mtr
PHS 48	16.80	Per Mtr	30x10, 30x6, 25x12	48	50 Mtr
PHS 55	18.96	Per Mtr	38x6, 30x12	55	50 Mtr
PHS 61	21.12	Per Mtr	40x10, 40x6, 38x12, 38x9	61	50 Mtr
PHS 73	25.60	Per Mtr	50x6	73	50 Mtr
PHS 81	28.06	Per Mtr	50x12, 50x10	81	50 Mtr
PHS 93	32.39	Per Mtr	75x6	93	50 Mtr
PHS 103	37.93	Per Mtr	75x12	103	50 Mtr
PHS 110	40.47	Per Mtr	90x2, 90x6	110	50 Mtr
PHS 128	47.03	Per Mtr	100x9, 100x6,	128	50 Mtr
PHS 140	51.35	Per Mtr	100x12	140	50 Mtr
PHS 170	62.76	Per Mtr	125x10, 125x6	170	50 Mtr
PHS 190	70.00	Per Mtr	150x12, 150x10, 150x6	190	50 Mtr
PHS 210	77.40	Per Mtr	175x12, 175x10, 175x6	210	50 Mtr
PHS 230	84.51	Per Mtr	200x12	230	50 Mtr

## TECHNICAL PARAMETERS

SR.NO	DESCRIPTION	TEST METHOD	RESULTS
1	Working Temperature	.....	94.73 C
2	Dielectric Strength	4STMD149	15kV/mm
3	Insulation Resistance	.....	20x10
4	Tensile Strength	ASTMD638	397 kg/cm2
5	Ultimate Elongation	ASTMD638	12.1%
6	Shrinking Temperature	ASTME28	150-155 C



# SPIRAL WRAPS

<b>MATERIAL</b>	PVC
<b>COLOR</b>	NATURAL / GREY (RAL 7035)

## WHY PECOX?

- > Spirals are heavy duty and Comply to RoHS directives.
- > FR Grade is also available at EXTRA COST.

## PACKAGING & PRICING

PRODUCT CODE	LIST PRICE (INR)	UNIT	O.D (mm)	DESCRIPTION THICKNESS (mm)	STANDARD PKG	MASTER PKG
PSW6	248.00	Roll	6	0.5 + 5	50 Mtr	50
PSW6	248.00	Roll	9	0.5 + 5	25 Mtr	50
PSW12	417.00	Roll	12	0.6 + 5	25 Mtr	20

# SELF-LOCKING NON-RELEASABLE CABLE TIE



**MATERIAL**

Pa66

**COLOR**

BLACK/WHITE

## WHY PECO X?

> Low Smoke Halogen Free (LSZH) Cable ties make very low levels of smoke and toxic fumes when burnt.

> Ziplock Packing stabilizes the hydrophobicity impact on cable ties helps in retaining the moisture during storage for later use making the cables ties flexible for installation .

### PREMIUM SERIES

### TECHNICAL DATASHEET/ PRICING/ PACAGING

PRODUCT CODE	LIST PRICE (INR)	NOMINAL OVERALL LENGTH (mm)	STRAP WIDTH (mm)	MAX BUNDLE CABLE DIA (mm)	MIN LOOP TENSILE STRENGTH		STANDARD PKG	MASTER PKG
					kgl	lbs		
PCT10025	478.46	100	2.5	20	8	18	1000	65
PCT10025S	53.36	100	2.5	20	8	18	100	500
PCT15036	129.77	150	3.6	35	18	40	100	250
PCT20036	164.10	200	3.6	35	18	40	100	200
PCT25048	291.45	250	4.8	60	22.7	50	100	130
PCT30048	335.29	300	4.8	75	22.7	50	100	100
PCT40048	484.47	400	4.8	100	23	50	100	90
PCT45048	521.72	450	4.8	100	23	50	100	90
PCT10025SUV	60.60	100	2.5	20	8	18	100	500
PCT15036UV	148.40	150	3.6	35	18	40	100	250
PCT20036UV	187.83	200	3.6	35	18	40	100	200
PCT25048UV	333.81	250	4.8	60	22.7	40	100	130
PCT30048UV	384.18	300	4.8	75	22.7	50	100	100
PCT40048UV	538.32	450	4.8	100	23	50	100	90
PCT45048UV	601.14	450	4.8	100	23	50	100	90

### ECO SERIES

### TECHNICAL DATASHEET/ PRICING/ PACAGING

PRODUCT CODE	LIST PRICE (INR)	NOMINAL OVERALL LENGTH (mm)	STRAP WIDTH (mm)	MAX BUNDLE CABLE DIA (mm)	MIN LOOP TENSILE STRENGTH		STANDARD PKG	MASTER PKG
					kgl	lbs		
PKCT10022	295.53	100	2.2	20	8	18	18	80
PKCT100225	34.71	100	2.2	20	8	18	18	80
PKCT15022	53.75	150	2.2	35	8	18	18	50
PKCT15030	77.07	150	3	35	18	40	40	230
PKCT20030	96.96	200	3	35	18	40	40	200
PKCT25040	185.20	250	4	60	23	50	50	150
PKCT30040	207.26	300	4	75	23	50	50	125
PKCT30040UV	226.77	300	4	75	23	50	50	125

NOTE - \* PRODUCTS ARE AVAILABLE IN P-KONNECT BRAND(AN ECO-SERIES OF PECO X)

## TIE MOUNTS

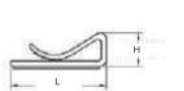
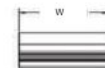
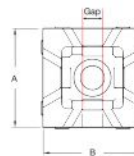
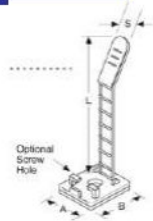

### TECHNICAL DATASHEET/ PRICING/ PACKAGING

PRODUCT CODE	LIST PRICE (INR)	UNIT	DESCRIPTION	A(mm)	WEIGHT (mm)		LENGTH (mm)	STANDARD PKG	MASTER PKG
PTM19	3.90	Nos	TIE MOUNTS - STANDARD	19	19	NA		100	6000
PTM25	5.15	Nos	TIE MOUNTS - STANDARD	25	25	NA		100	6000
PTML1	13.15	Nos	LADDER TYPE	20	29.2	84		50	3000
PTMF1	12.10	Nos	FLAT TYPE	24.7	29.7	14.4		50	3000
PTMS1	5.00	Nos	SCREW TYPE	NA	NA	NA		100	3000

# NYLON POLYIMIDE FLEXIBLE CONDUITS

<b>MATERIAL</b>	PA6
<b>COLOR</b>	BLACK

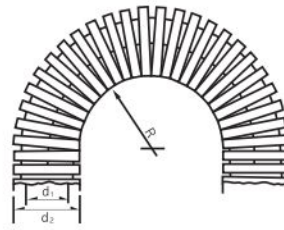

## WHY PECOx?

> Best Premium quality of PA6, provides flexibility along with mechanical strength.

## TECHNICAL DATESHEET PACKAGING & PRICING

PRODUCT CODE	LIST PRICE (INR)	UNIT	DIMENSIONS			STANDARD PKG	MASTER PKG
			INNER DIAMETER D1(mm)	OUTER DIAMETER D2(mm)	BENDING RADIUS R(mm)		
PPCPG-7	24.00	Nos	6.5	10	20	100	30
PPCPG-9	26.00	Nos	10	13	30	100	20
PPCPG-11	35.00	Nos	12	15.80	40	50	20
PPCPG-13.5	41.00	Nos	14	18.50	42	50	18
PPCPG-16	49.00	Nos	17	21.20	45	50	16
PPCPG-21	76.00	Nos	23	28.50	55	50	10
PPCPG-29	98.00	Nos	29	34.50	60	25	10
PPCPG-36	147.00	Nos	36	42.50	65	25	8
PPCPG-48	285.00	Nos	48	54.50	80	25	5

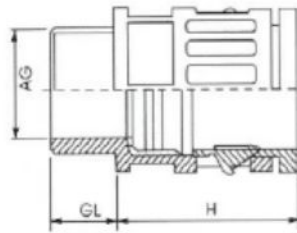

## CONDUIT GLANDS

<b>MATERIAL</b>	POLYAMIDE
<b>TEMPERATURE PROTECTION</b>	MIN -40 TO MAX +105 DEGREE
<b>COLOR</b>	BLACK

PRODUCT CODE	LIST PRICE (INR)	UNIT	DIMENSIONS				STANDARD PKG	MASTER PKG
			AG(mm)	AG(mm) THREAD LENGTH	GL(mm)	H(mm)		
PPCGPG-7	25.00	Nos	12.3	6.5	11.5	18	100	
PPCGPG-9	28.00	Nos	15	10	11.5	19	100	
PPCGPG-11	34.00	Nos	18.4	12.5	12	23	100	
PPCGPG-13.5	38.00	Nos	20.2	14.3	12	12	100	
PPCGPG-16	41.00	Nos	22.3	17.0	13	27	100	
PPCGPG-21	53.00	Nos	28	23	13	33	100	
PPCGPG-29	59.00	Nos	36.7	29	15	35	50	
PPCGPG-36	75.00	Nos	46.7	36	15	38.5	10	
PPCGPG-48	113.00	Nos	59	53	16	39	10	



## JUNCTION BOX

MATERIAL	THERMOPLASTIC
COLOR	RAL7035(GREY)
IP RATING	IP65
GASKET	SILICON

### WHY PECOx?

> Unique Clamping Mounting Arrangements.

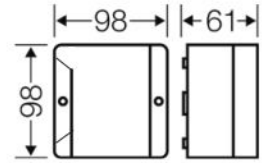

CLAMPS

### TECHNICAL DATASHEET

Product Code	List Price (Rs)	Unit	Dimensions	Standard Packing (No)	Master Packing (No)
PJB 9040	190.00	No	100*100*65	5	230
PJB 9060	325.00	No	140*120*75	4	160
PJB 9100	475.00	No	167*125*80	4	72
PJB 9250	650.00	No	200*160*95	1	50

### ACCESSORIES - PACKAGING & PRICING

PRODUCT CODE	LIST PRICE (INR)	Unit	DESCRIPTION	STANDARD PACKAGING	MASTER PACKAGING
PJBC1	25.00	Per pair	MOUNTING CLAMP		
PJBTI	100.00	No	5WAY CONNECTOR Suitable for 25.4 5qmm		

## DISTRIBUTION BOXES

BASE	ENGINEERING GRADE GLASS FILLED THERMOPLASTIC
COVER	RAL7035
IP RATING	IP66/IP67
RASISTANCE	Ik08
THICKNESS	3 mm



### TRANSPARENT LID

PRODUCT CODE	LIST PRICE (INR)	UNIT	DIMENSIONS (mm)	STANDARD PKG	MASTER PKG
PJBH181810T	960.00	Nos	180x180x105		
PJBH282013T	1620.00	Nos	280x200x130		
PJBH303015T	2120.00	Nos	300x300x150		

### OPAQUE LID

PRODUCT CODE	LIST PRICE (INR)	UNIT	DIMENSIONS (mm)	STANDARD PKG	MASTER PKG
PJBH1818100	910.00	Nos	180x180x105		
PJBH2820130	1540.00	Nos	280x200x130		
PJBH3030150	2020.00	Nos	300x300x150		

### WHY PECOx?

> External mounting arrangement.

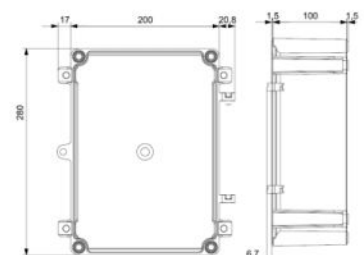
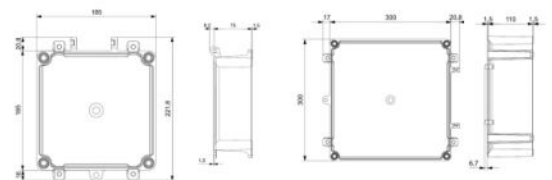



**PeCOx**<sup>®</sup>

Quality Never Dies  
Engineered For Electrical Control Panels

Nurturing A Sustainable Growth By **REJECTING** The Use Of  
**SINGLE USE THERMOSET PLASTIC (DMC, SMC, MELAMINE, BAKELITE)**  
Substituting It With  
**ENGINEERING GRADE THERMOPLASTIC**

